

**HONDA**

# Emergency Response Guide

For Hybrid Vehicles



2010 Model Year  
Edition

# Introduction

This booklet has been prepared to help emergency response professionals identify Honda gasoline-electric hybrids and respond safely to incidents involving these vehicles.

Part 1 presents general information and recommendations that apply to all Honda hybrids produced through the 2010 model year. Part 2 contains model-specific information for each of the three hybrid models: the Insight, the Civic Hybrid, and the Accord Hybrid. This guide will be updated or replaced as Honda, and Acura, continue to introduce new hybrid vehicles.

We hope this publication provides the kind of information you need. This booklet is available for reference or downloading at <https://techninfo.honda.com>. If you have any questions or wish to order additional printed copies please contact your local Honda dealer or Honda Automobile Customer Service at 1-800-999-1009.

American Honda wants to thank you for your concern and efforts in protecting Honda customers and the general public.

# Contents

Introduction	i
<b>Part 1: Information for All Honda Hybrids</b>	
Vehicle Description	2
Identifying a Honda Hybrid	2
Gasoline Engine	3
Electric Motor	3
12-Volt Battery	3
Underhood Fuse Box	3
Positive Battery Terminal	3
High-Voltage Battery Module	4
High-Voltage Battery Box	4
High-Voltage Cables	5
Potential Hazards	
Flammable Fluids	6
Undeployed Airbags and Tensioners	6
Electric Shock Potential	7
High-Voltage Battery Electrolyte	8
12-Volt Battery Electrolyte	8
Emergency Procedures	
Vehicle Fire	9
Submerged or Partially Submerged Vehicle	9
Preventing Current Flow Through High-Voltage Cables	9
Best Method for Preventing High-Voltage Flow (All Models)	10
Second-Best Method for Preventing High-Voltage Flow (Except 2010 Insight)	10
Second-Best Method for Preventing High-Voltage Flow (2010 Insight)	12
Extricating Occupants	13
Moving or Towing a Honda Hybrid	13
<b>Part 2: Model-Specific Information</b>	
2000-2006 Honda Insight	14
2010 Honda Insight	16
2003-2005 Honda Civic Hybrid	18
2006-2010 Honda Civic Hybrid	20
2005-2007 Honda Accord Hybrid	22



All Honda Insights have an aerodynamic shape. Older models (top above) have two doors, the 2010 model (directly above) has four.



Like the Civic Hybrid above, all Honda hybrids other than the Insight look essentially the same as their conventional counterparts.

### HYBRID

A label or badge is displayed on the rear of all Honda hybrids.



Orange cables under the hood, or orange shielding bolted to the undercarriage of a Honda tell you the vehicle is a hybrid.

### IDENTIFYING A HONDA HYBRID

The Insight can be identified by its aerodynamic shape and by the name Insight and a hybrid badge on the rear of the vehicle. The 2000-2006 models have rear fender skirts, the 2010 model does not.

Except for a few minor differences in equipment, such as a roof antenna, there is very little difference in the exterior or interior appearance of the Civic and Accord hybrids compared to those of their gasoline-powered counterparts.

The easiest way to identify a hybrid is by the words Gasoline-Electric HYBRID, which appear on the rear of the vehicle, on either the driver's or the passenger's side.

If a hybrid badge or label is not visible on the rear of the vehicle, due to damage for example, the presence of orange cables under the hood, or orange shielding under the car, would also identify the vehicle as a hybrid.

### **GASOLINE ENGINE**

The main power source of all Honda hybrids is a conventional gasoline engine, located under the hood.

### **ELECTRIC MOTOR**

During start-up and acceleration, an electric motor, located between the engine and the transmission, provides assistance to the engine. During braking and deceleration, the motor acts as a generator, recharging both the high-voltage battery module and the 12-volt battery.

### **12-VOLT BATTERY**

A conventional 12-volt battery, also located under the hood, powers all standard electronics. In Honda hybrids, this battery also provides power to the high-voltage battery control systems. Disconnecting or cutting the negative cables to the battery may be necessary in some emergency situations.

### **UNDERHOOD FUSE BOX**

All Honda hybrids except the 2010 Insight have a fuse box under the hood on the driver's side of the engine compartment. Removing the main fuse from the box may be required in some emergency situations.

### **POSITIVE BATTERY TERMINAL**

The 2010 Insight does not have a conventional underhood fuse box. Instead, the main fuse is located in the positive battery terminal. Cutting or removing the DC to DC converter cable, which is connected to this terminal, may be required in some emergency situations.

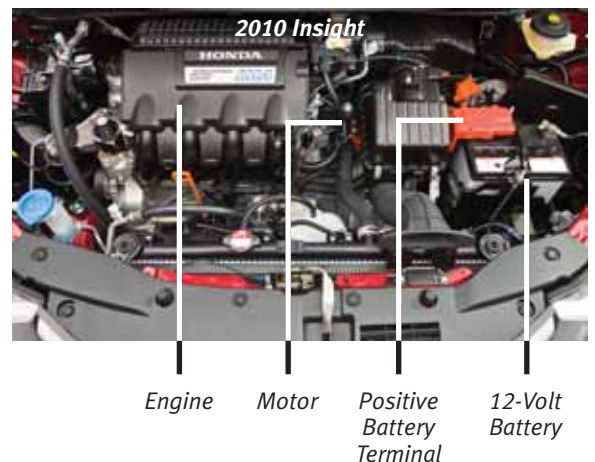
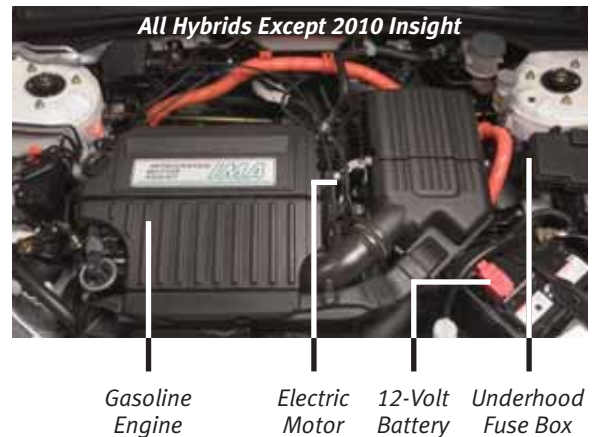



*HV Battery Module*      *Single HV Battery "Stick"*      *Single HV Cell*      *D-Cell Battery*



*Other High-Voltage Components*      *High-Voltage Battery Module*

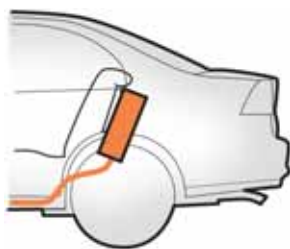

*Typical Location of High-Voltage Battery Box*

**HIGH-VOLTAGE BATTERY MODULE**

The electric motor is powered by a nickel-metal-hydrate (NiMH) battery module. The module contains groups, or "sticks," of 1.2-volt cells, each about the size of a D-cell battery. The number of cells varies by vehicle model, and total voltages range from 100-160 volts.

Since the battery module is recharged by the electric motor whenever the vehicle decelerates, the battery does not need external charging.

**HIGH-VOLTAGE BATTERY BOX**

The high-voltage battery module is stored in a sturdy box, such as the one shown here with the lid removed. The box contains other important components which, together with the battery, make up the Intelligent Power Unit (IPU). All components inside the battery box are completely insulated and isolated from the vehicle body.

For maximum safety, the high-voltage battery box is positioned behind the seat-backs where it is well-protected from potential damage in a collision.

### HIGH-VOLTAGE CABLES

Electrical energy flows between the high-voltage battery module and the motor through three heavy-duty orange cables.

In the Accord Hybrids and the 2006-2010 Civic Hybrids, high-voltage cables also deliver current to the air conditioning (AC) compressor. This allows the AC to continue running when the vehicle is in the Auto Idle Stop mode. (Under certain conditions, Auto Idle Stop automatically turns the engine off when the car comes to a stop, at a stop light for example.)

Between the battery box and the engine compartment, the high-voltage cables are routed under the vehicle, inside sturdy orange plastic protective shields. Where the cables lie close to the exhaust system, a metal thermal shield covers, but does not obscure, the orange high-voltage shield.

To improve aerodynamics and fuel efficiency, some sections of the high-voltage cables are located behind paneling. High-voltage alert symbols (⚠) may be stamped into the paneling to indicate the cables' path.



*High-Voltage Cable Connection to Motor*



*High-Voltage Cable to Accord AC Compressor*



*Electrical shield bolted to undercarriage*



*Thermal shield near hot exhaust*



*High-Voltage Cable Visible*

*Undercarriage Cover*

*High-Voltage Alert Symbols*



*Follow recommended procedures to avoid possible injury from a deploying airbag or inflator.*

Honda hybrids do not present any unusual hazards. The vehicles have performed well in standard crash tests, with no damage to high-voltage components in front, side, or rear impacts.

### **FLAMMABLE FLUIDS**

Gasoline-electric hybrids have the same potential fire and explosion hazards as conventional vehicles. (See model-specific pages for flammable fluid capacities.)

### **UNDEPLOYED AIRBAGS AND TENSIONERS**

All Honda hybrids have front airbags and front seat belt tensioners. The Accord, Civic, and 2010 Insight hybrids also have side airbags for front-seat occupants. The Accord, 2006-2010 Civic, and 2010 Insight hybrids are also equipped with side curtain airbags. These systems all use pyrotechnic devices with a deactivation time of 3 minutes.

As with other airbag-equipped vehicles, being struck by a deploying front or side airbag, or cutting into an unactivated inflator, can result in moderate to severe injuries. Injuries can also result from contact with a deploying side curtain airbag, or having a seat belt tensioner activate unexpectedly.

To reduce the risk of injury during the deactivation period, we recommend the following:

- Keep out of the path of an undeployed front airbag, and do not cut into the center of the steering wheel or dashboard where the front airbags are stored.
- Do not cut into the rear (C) pillar on the Accord, 2006-2010 Civic, or 2010 Insight hybrids where the side curtain inflator is stored.
- Be aware that extreme heat (320-356°F; 160-180°C) can cause unintended airbag inflation.

## ELECTRIC SHOCK POTENTIAL

Unprotected contact with any electrically charged (“hot” or “live”) high-voltage component can cause serious injury or death. However, **receiving an electric shock from a Honda hybrid is highly unlikely** because of these facts:

- Contact with the battery module or other components inside the battery box can occur only if the box is damaged and the contents are exposed, or the box is opened without following proper precautions.
- Contact with the electric motor can occur only after one or more components are removed.
- The high-voltage cables can be easily identified by their distinctive orange color, and contact with them can be avoided.

It’s also important to understand in what situations the high-voltage cables can potentially be “hot”:

**All Honda Hybrids:** Whenever the ignition switch is in the ON position and the engine is running, the high-voltage battery is either supplying current to the electric motor or receiving current generated by the electric motor.

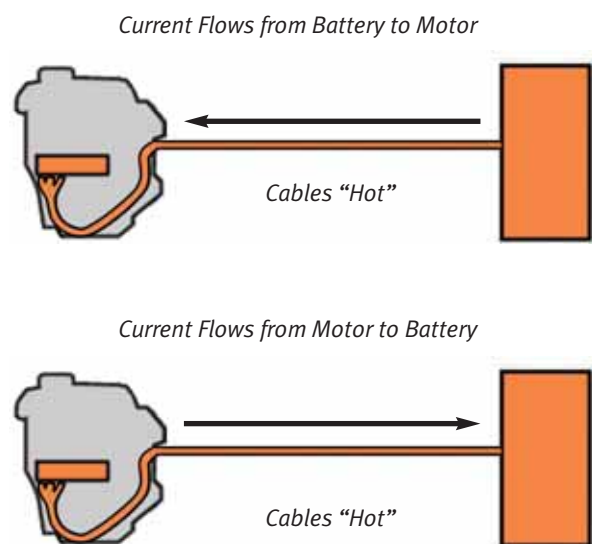

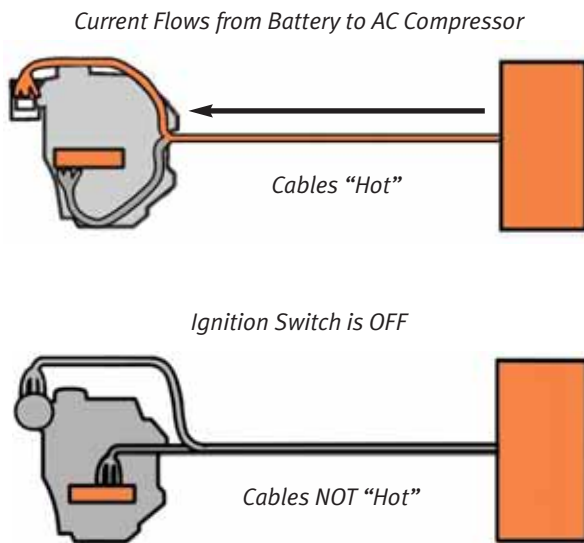

Electrolyte in the high-voltage battery cells is non-liquid and should not present a hazard.

**Accord and 2006-2010 Civic Hybrids:** With these models, the high-voltage battery powers the air conditioner compressor as well as the electric motor. So, if the ignition switch is in the ON position, the air conditioner is on, and the engine has been turned off by the Auto Idle Stop feature (at a stop light, for example), current will flow through the cables to the air conditioner compressor.

Regardless of the model, if the ignition switch is turned off, the flow of high-voltage current will stop.

The lesson, therefore, is: ***Electric current cannot flow into the high-voltage cables when the ignition is OFF.***

**HIGH-VOLTAGE BATTERY ELECTROLYTE**

Small quantities of a highly alkaline liquid electrolyte, which is corrosive to human tissue, are used in the manufacture of the high-voltage battery cells. However, in the finished cells, electrolyte is non-liquid and sealed in a sturdy case, and any leakage would be extremely rare.

Moreover, the electrolyte is non-flammable, non-explosive, and creates no hazardous fumes or vapors in normal operating conditions.

**12-VOLT BATTERY ELECTROLYTE**

Any hazards from contact with the 12-volt battery electrolyte are the same as those with batteries in conventional passenger vehicles.

Based on discussions with rescue professionals, we recommend that emergency response personnel follow standard procedures developed by their own organization for assessing situations and dealing with potential hazards. Given our knowledge of Honda hybrids, we also recommend that you use the procedures outlined in this section.

### VEHICLE FIRE

There are no unusual hazards if a Honda hybrid or the high-voltage battery box is involved in a fire. It should be noted, however, that extremely high temperatures (320-356°F; 160-180°C) can cause undeployed airbags to deploy.

### SUBMERGED OR PARTIALLY SUBMERGED VEHICLE

Pull the vehicle out of the water, then use one of the procedures described below for preventing electric current from flowing through the high-voltage cables.

***There is no risk of electric shock from touching the car's body or framework—in or out of the water.***

### PREVENTING CURRENT FLOW THROUGH HIGH-VOLTAGE CABLES

Before attempting to rescue occupants or move a damaged Honda hybrid, you should reduce the potential for current to flow from the electric motor or the battery module through the high-voltage cables.

There are ***two recommended methods*** for preventing current flow. These are discussed on the following pages.



*Standard procedures are recommended if a Honda hybrid is involved in fire.*

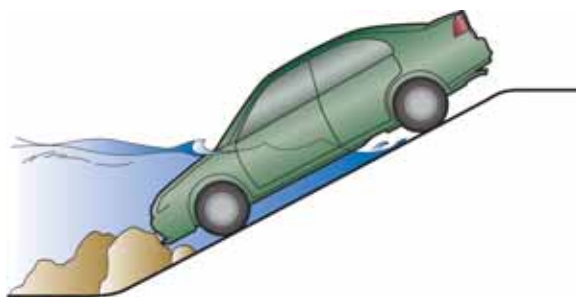

*Pull vehicle from water, then follow recommended procedures for preventing high-voltage current flow.*



*Turning the ignition key to the OFF position stops the flow of electricity in the cables.*

**BEST METHOD FOR PREVENTING HIGH-VOLTAGE CURRENT FLOW (ALL MODELS)**

***Turn the ignition switch off.***

This simple action turns off the engine and the electric motor, preventing current flow into the cables. It also turns off power to the airbags and the seat belt tensioners.

After you turn the ignition switch off, remove the key so the car cannot be accidentally restarted.

**SECOND-BEST METHOD FOR PREVENTING HIGH-VOLTAGE CURRENT FLOW (EXCEPT 2010 INSIGHT)**

***Cut both negative 12-volt battery cables and remove the main fuse.***

Together, cutting the negative 12-volt battery cables and removing the main fuse turns off the engine and the electric motor and cuts power to the high-voltage system controllers, thereby preventing current flow into the cables. It also cuts power to the airbags and the seat belt tensioners.

# Emergency Procedures

## Part: 1

1. Locate the 12-volt battery and cut the negative cables with diagonal cutters.



*Negative Cables*

2. Locate the underhood fuse box, and remove the cover (see model-specific pages for fuse box locations).
3. Locate the main fuse by referring to the diagram on top of, or inside, the fuse box cover. (The 2000-2006 Insight fuse box is shown here only as an example. See the model-specific pages for photos of the Civic and Accord Hybrid fuse boxes.)



*Fuse Box  
Cover*

*Main Fuse*

4. Using a Phillips screwdriver, unscrew the main fuse assembly and remove it from the box. (The Civic Hybrid main fuse screws are shown here as an example. See model-specific pages for location of the main fuse screws in the 2000-2006 Insight and Accord Hybrid.)



*Main Fuse  
Screws*

**NOTE: If you cannot perform either method to stop the engine and prevent current flow into the high-voltage cables, use extreme care, do not cut into the cables, and do not touch damaged cables as they may be “hot.”**

**SECOND-BEST METHOD FOR PREVENTING  
HIGH-VOLTAGE CURRENT FLOW  
(2010 INSIGHT)**

***Cut the negative 12-volt battery cable, then cut  
or disconnect the DC to DC converter cable  
at the positive battery terminal.***

Together, cutting the 12-volt negative cable and cutting or disconnecting the DC to DC converter cable turns off the engine and the electric motor and cuts power to the high-voltage system controllers. This stops the flow of current into the high-voltage cables and cuts power to the airbags and the seat belt tensioners.

1. Locate the 12-volt battery and cut the negative battery cable.



12-Volt  
Battery

Negative  
Battery  
Cable



Positive Battery  
Terminal

2. Locate the positive battery terminal and remove the cover.

3. Cut or disconnect the DC to DC converter cable.



*DC to DC  
Converter Cable  
Connection*

### **EXTRICATING OCCUPANTS**

If cutters or spreaders are needed to allow occupants to be rescued, make sure to stay within the cut zones recommended on the following pages.

### **MOVING AND TOWING A HONDA HYBRID**

If a disabled vehicle needs to be moved a short distance (to the side of the road, for example), and the car can still roll on the ground, the easiest way is to shift the transmission into neutral and manually push the vehicle.

To transport a vehicle away from an emergency location, a flatbed truck should be used if the vehicle might be repaired. If a flatbed is not available, the vehicle should be towed by wheel-lift equipment with the front wheels off the ground. Do not use sling-type towing equipment unless the car has been damaged beyond repair.

**IDENTIFYING THE INSIGHT**



2000-2006 Insight models are 2-passenger cars with a distinctive aerodynamic shape and rear fender skirts.



Depending on the model year, a hybrid label will appear on the right or left rear of the vehicle.

**KEY COMPONENTS**

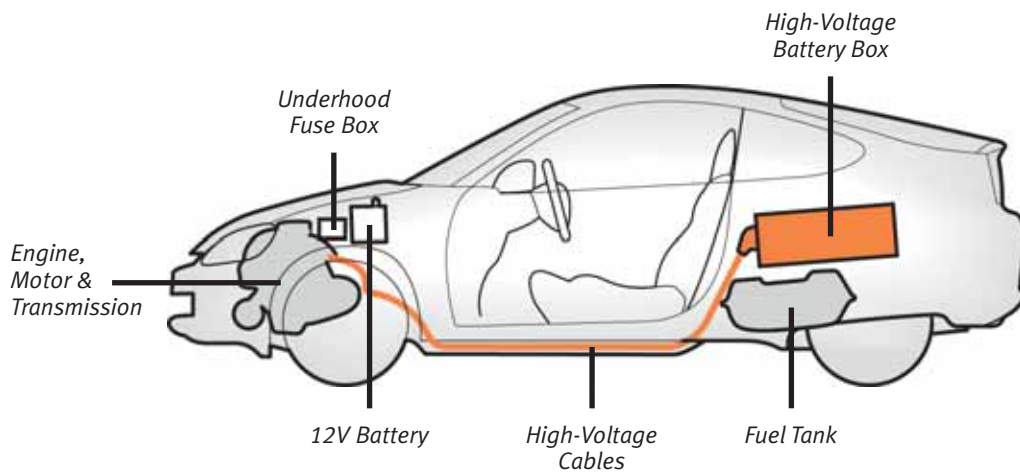
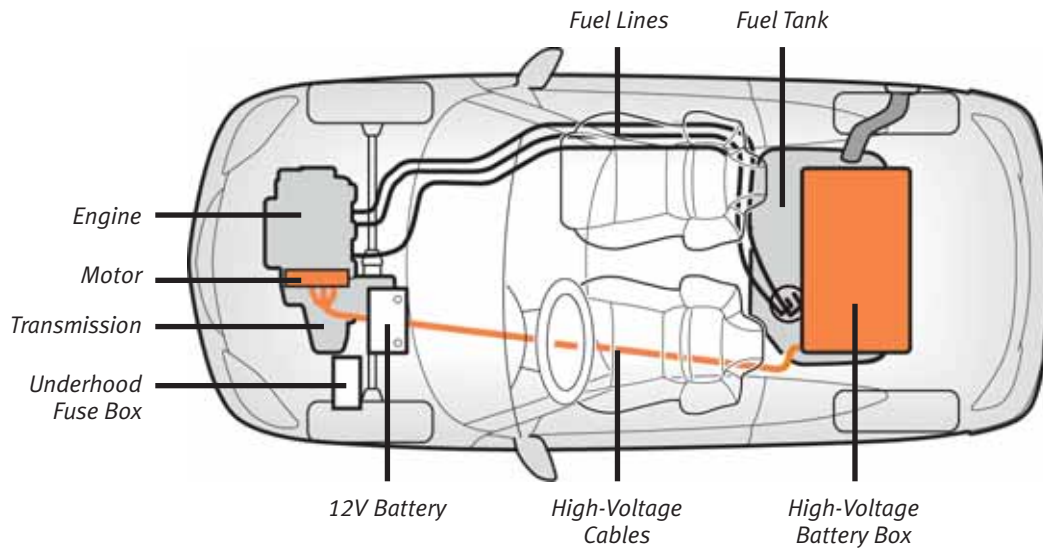

## FLAMMABLE FLUIDS

Gasoline:	10.6 gallons (40 liters)
Engine Oil:	3.2 quarts (3.0 liters)
Transmission Fluid:	
CVT:	3.4 quarts (3.2 liters)
Manual:	1.6 quarts (1.5 liters)

## AIRBAGS AND TENSIONERS

Front Airbags:	Driver & passenger
Tensioners:	Driver & passenger

## UNDERHOOD COMPONENTS

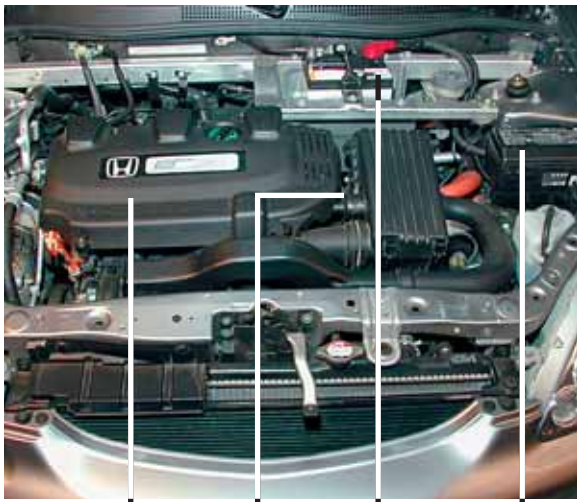

Engine

Motor

12-Volt  
Battery

Underhood  
Fuse Box

## MAIN FUSE LOCATION

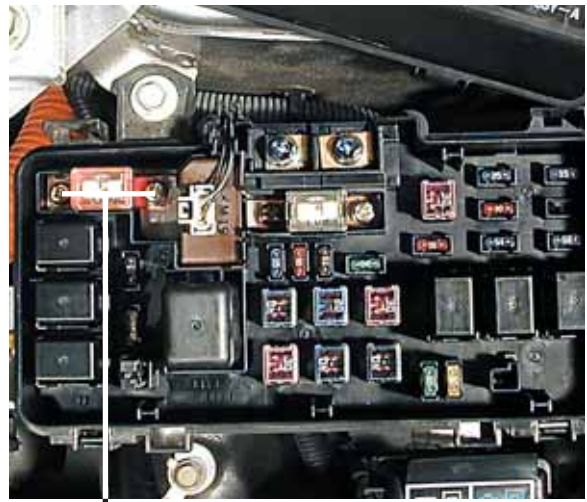

Main Fuse  
Screws

## CUT ZONE

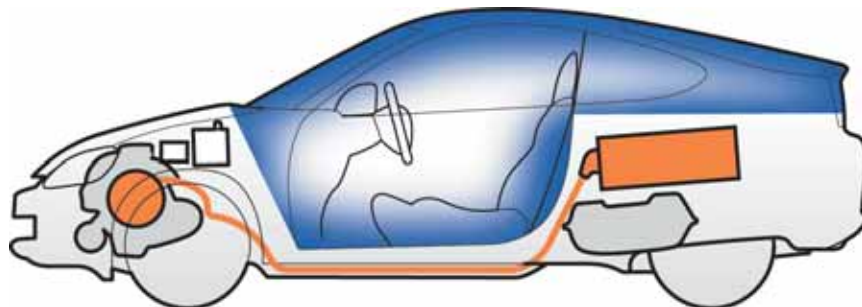

**IDENTIFYING THE INSIGHT**



The 2010 Insight is a 4-door, 5-passenger vehicle.



A hybrid badge appears on the right rear of the vehicle.

**KEY COMPONENTS**

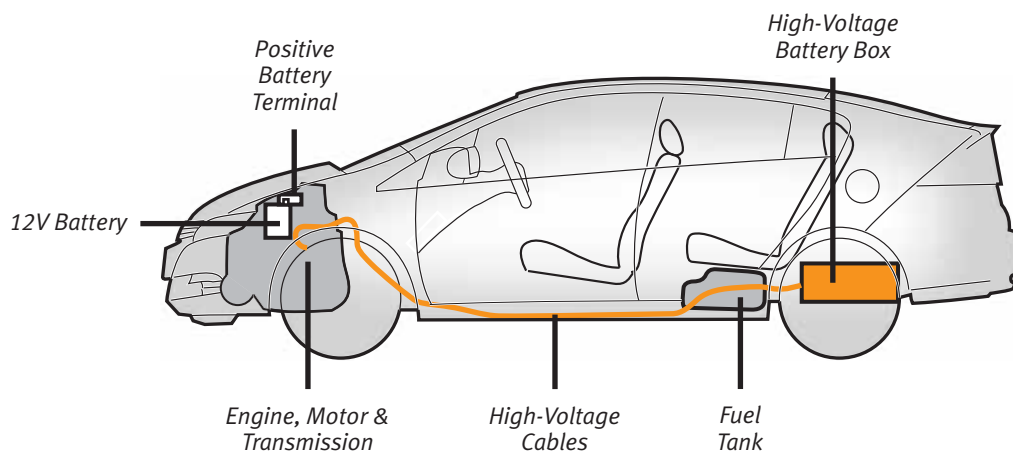
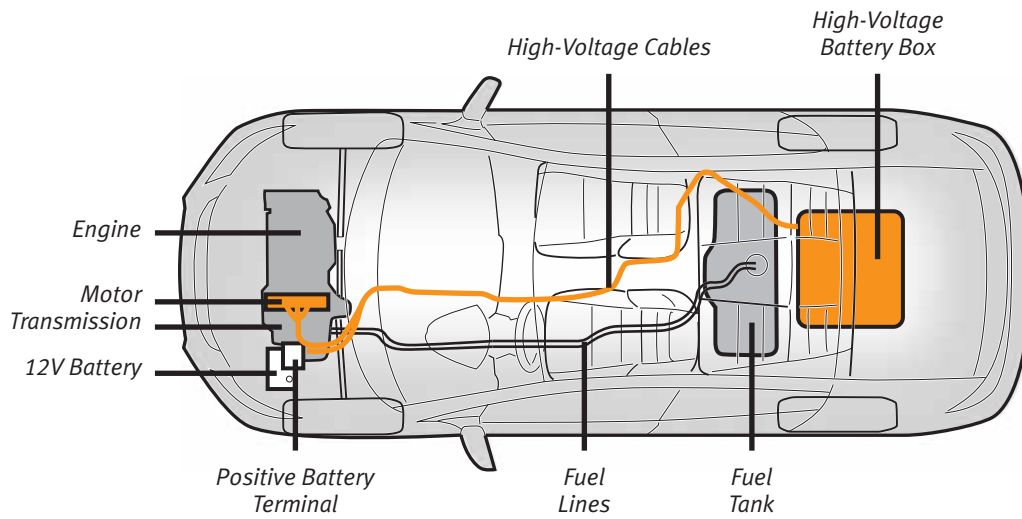

### FLAMMABLE FLUIDS

Gasoline:	10.6 gallons (40 liters)
Engine Oil:	3.8 quarts (3.6 liters)
Transmission Fluid:	5.5 quarts (2.2 liters)

### AIRBAGS AND TENSIONERS

Front Airbags:	Driver & passenger
Tensioners:	Driver & passenger
Side airbags:	Driver & front passenger
Side curtain airbags:	Front and rear seats

### UNDERHOOD COMPONENTS



Engine Motor Positive Battery Terminal 12-Volt Battery

### POSITIVE BATTERY TERMINAL



DC to DC Converter Cable Connection

### CUT ZONE

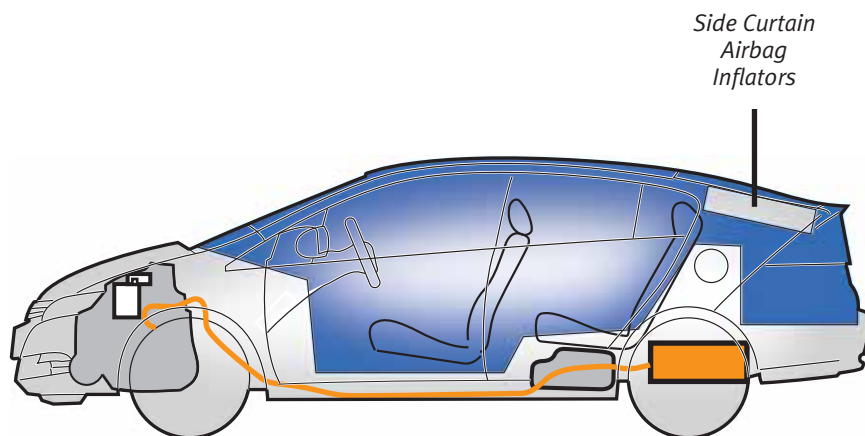

**IDENTIFYING THE CIVIC HYBRID**



The Civic Hybrid appears virtually the same as a conventional Civic.

Look for a Hybrid label or badge on the right or left rear at the level shown above.

**KEY COMPONENTS**

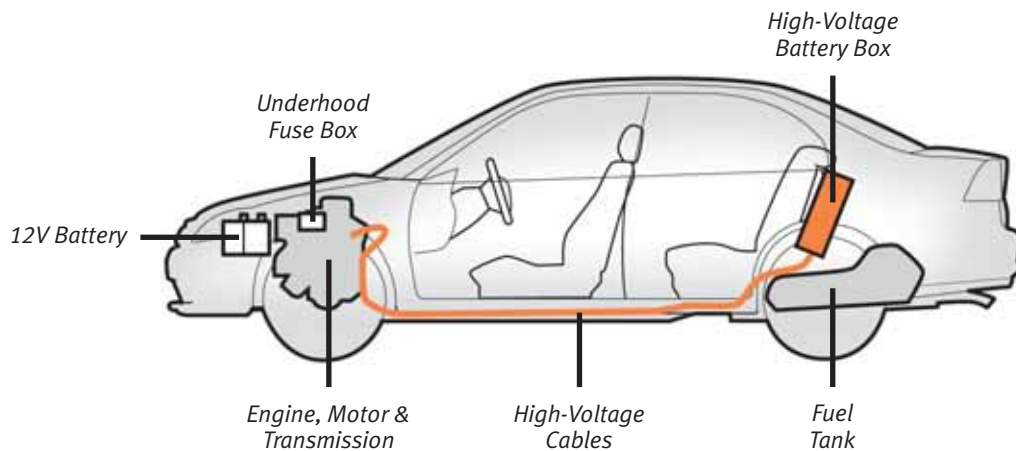
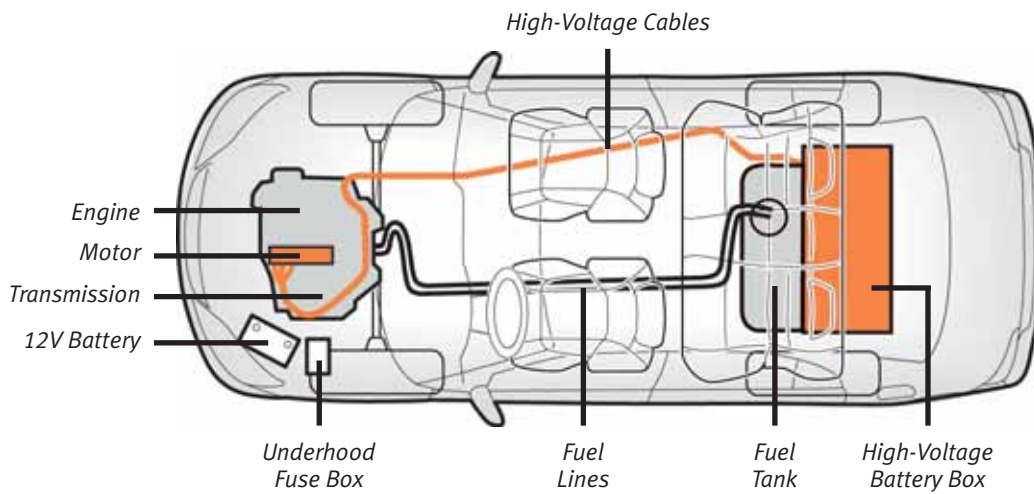

### FLAMMABLE FLUIDS

Gasoline:	13.2 gallons (50 liters)
Engine Oil:	3.2 quarts (3.0 liters)
Transmission Fluid:	
CVT:	3.4 quarts (3.2 liters)
Manual:	1.6 quarts (1.5 liters)

### AIRBAGS AND TENSIONERS

Front Airbags:	Driver & front passenger
Side Airbags:	Driver & front passenger
Tensioners:	Driver & front passenger

### UNDERHOOD COMPONENTS



Engine

Motor

12-Volt  
Battery

Underhood  
Fuse Box

### MAIN FUSE LOCATION



Main Fuse  
Screws

### CUT ZONE

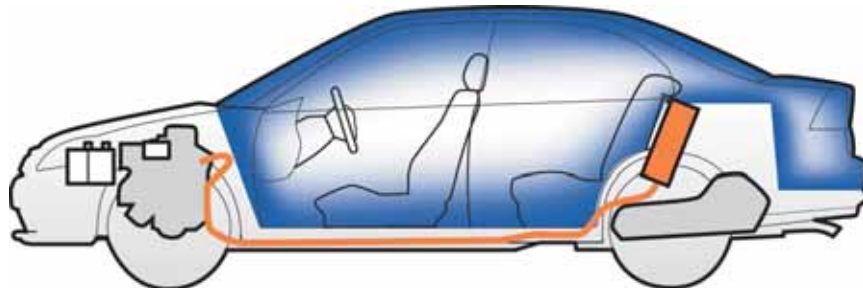

**IDENTIFYING THE CIVIC HYBRID**



The appearance of 2006-2010 Civic Hybrids is essentially the same as conventional Civic Sedans.

The word "Hybrid" appears on the right rear of these vehicles.

**KEY COMPONENTS**

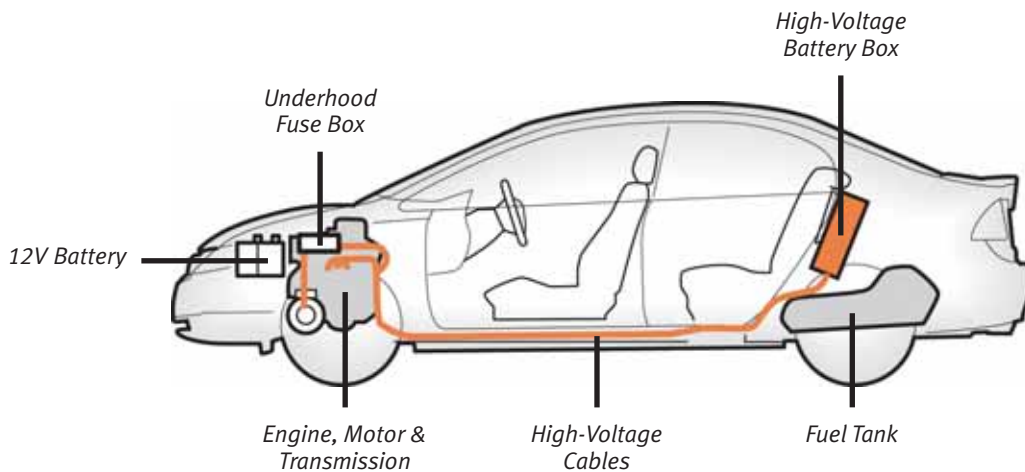
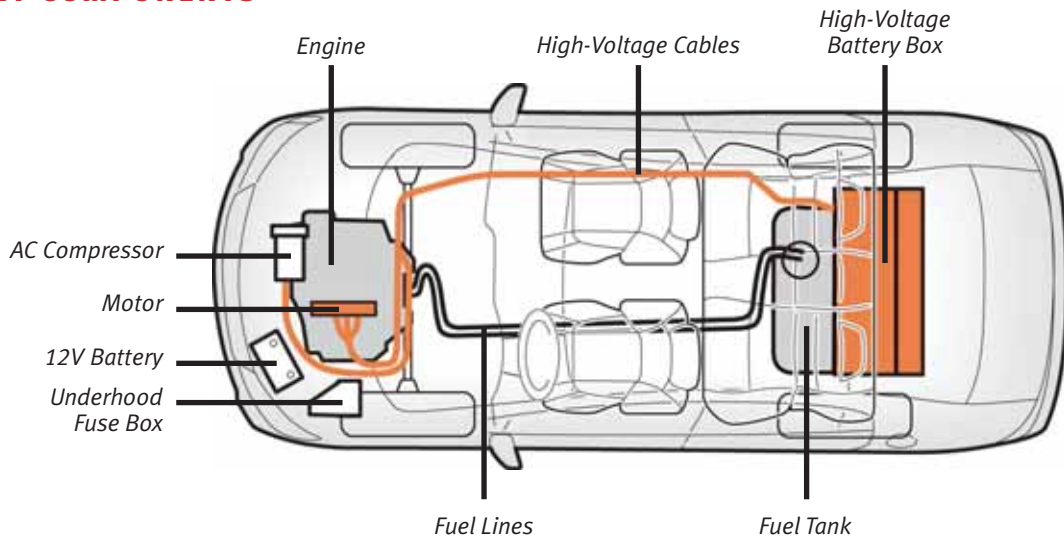

### FLAMMABLE FLUIDS

Gasoline: 12.4 gallons (47 liters)

Engine Oil: 4.0 quarts (3.8 liters)

Transmission Fluid: 5.4 quarts (5.1 liters)

### AIRBAGS AND TENSIONERS

Front Airbags: Driver & front passenger

Side Airbags: Driver & front passenger

Tensioners: Driver & front passenger

Side Curtain Airbags: Driver, front passenger & outer rear passengers

### UNDERHOOD COMPONENTS



Engine

Motor

12-Volt  
Battery

Underhood  
Fuse Box

### MAIN FUSE LOCATION



Main Fuse Assembly  
Screws

### CUT ZONE

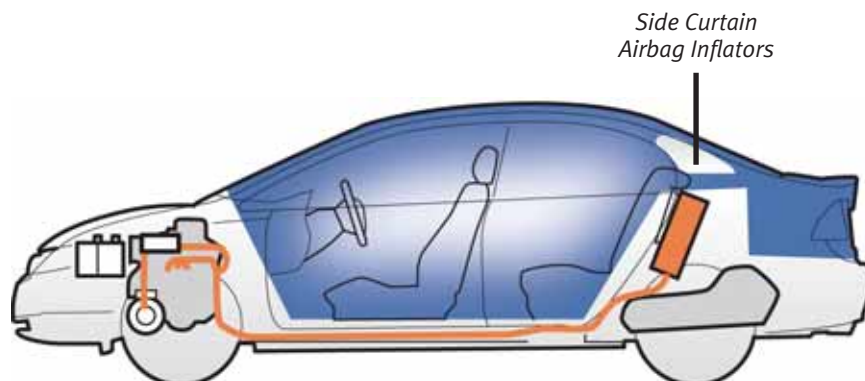

Side Curtain  
Airbag Inflators

**IDENTIFYING THE ACCORD HYBRID**



The appearance of an Accord Hybrid is essentially identical to that of a conventional Accord.



The word "Hybrid" appears directly under the name "Accord" above the right rear tail light.

**KEY COMPONENTS**

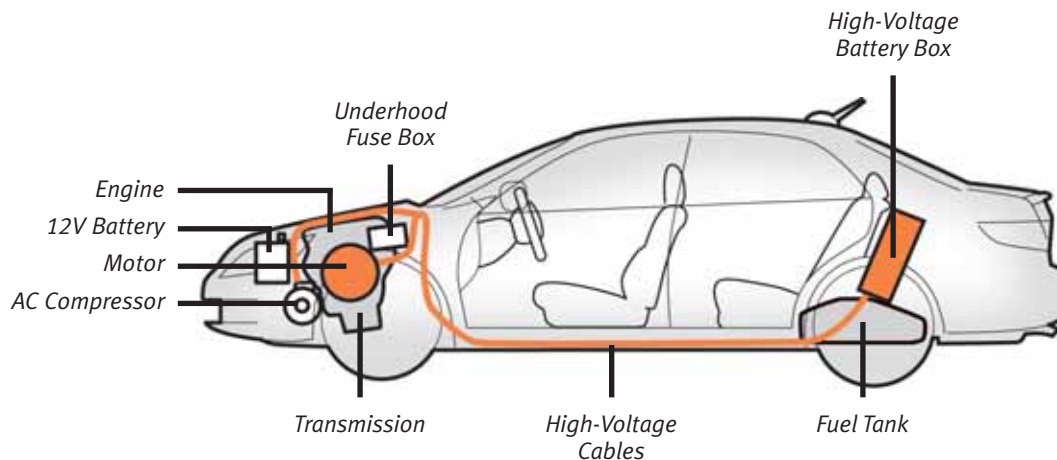

### FLAMMABLE FLUIDS

Gasoline:	17.1 gallons (64.7 liters)
Engine Oil	5.3 quarts (5.0 liters)
Transmission Fluid:	8.2 quarts (7.8 liters)

### AIRBAGS AND TENSIONERS

Front Airbags:	Driver & front passenger
Side Airbags:	Driver & front passenger
Tensioners:	Driver & front passenger
Side Curtain Airbags:	Driver, front passenger & outer rear passengers

### UNDERHOOD COMPONENTS



Engine      Motor      12-Volt Battery      Underhood Fuse Box

### MAIN FUSE LOCATION



Main Fuse Screw

### CUT ZONE

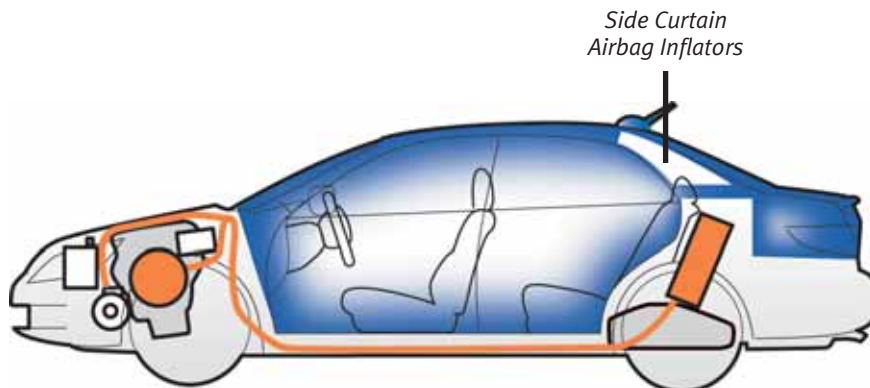

Side Curtain Airbag Inflators

Copyright © 2009, American Honda Motor Co., Inc.

Reorder Number Y0716